

INSTRUCTION MANUAL

AC VOLTMETER

MODEL 1834/1854

KIKUSUI ELECTRONICS CORPORATION, JAPAN

78-11-11

783421

Power Requirements of this Product

Power requirements of this product have been changed and the relevant sections of the Operation Manual should be revised accordingly.

(Revision should be applied to items indicated by a check mark)

Input voltage

The input voltage of this product is _____ VAC,
and the voltage range is _____ to _____ VAC. Use the product within this range only.

Input fuse

The rating of this product's input fuse is _____A, _____VAC, and _____.

WARNING

- To avoid electrical shock, always disconnect the AC power cable or turn off the switch on the switchboard before attempting to check or replace the fuse.
- Use a fuse element having a shape, rating, and characteristics suitable for this product. The use of a fuse with a different rating or one that short circuits the fuse holder may result in fire, electric shock, or irreparable damage.

AC power cable

The product is provided with AC power cables described below. If the cable has no power plug, attach a power plug or crimp-style terminals to the cable in accordance with the wire colors specified in the drawing.

WARNING

- The attachment of a power plug or crimp-style terminals must be carried out by qualified personnel.

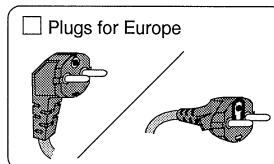
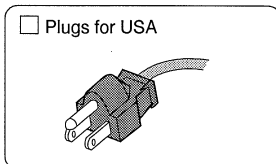
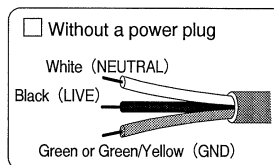
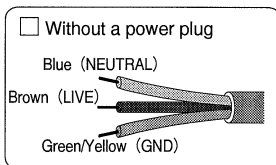

Provided by Kikusui agents

Kikusui agents can provide you with suitable AC power cable.
For further information, contact your Kikusui agent.

Another Cable _____

TABLE OF CONTENTS

| | PAGE |
|--|------|
| 1. GENERAL | 1 |
| 2. SPECIFICATIONS | 2 |
| 3. OPERATION METHOD | 5 |
| 3.1 Explanation of Front and Rear Panels | 5 |
| 3.2 Preparations for Measurement | 9 |
| 3.3 AC Voltage Measurement | 10 |
| 3.4 AC Current Measurement | 12 |
| 3.5 Use as Output Meter | 13 |
| 3.6 Waveform Errors | 13 |
| 3.7 Decibel | 14 |
| 4. OPERATING PRINCIPLE | 21 |
| 4.1 Construction | 21 |
| 4.2 Input Section | 21 |
| 4.3 Latter-stage Attenuator | 23 |
| 4.4 Main Amplifier | 24 |
| 4.5 Meter Drive Circuit | 24 |
| 4.6 Output Circuit | 25 |
| 4.7 Power Supply | 25 |
| 5. MAINTENANCE | 26 |
| 5.1 Inspection of Internal Components | 26 |
| 5.2 Adjustment and Calibration | 27 |
| 5.3 Troubleshooting | 29 |
| 5.4 AC Line Voltage Modification | 32 |

783422

1. GENERAL

Model 1834/1854 is a high-sensitivity 2-pointer electronic AC voltmeter which indicates two signals at the same time. The voltmeter is made of solid-electronics, consumes less power, and is compact and light. It indicates the mean value of the measured signal.

The 1834/1854 AC voltmeter is identical except for their measuring ranges. This instruction manual explains Model 1834 primarily, giving the difference alone of Model 1854 being enclosed in [].

The measuring range selection system is very convenient. When the red button on the knob is pushed-in and locked, both INPUT 1 and INPUT 2 can be switched at the same time in gang. When the button is pulled-out and unlocked, INPUT 1 and INPUT 2 can be switched mutually independently. It is also possible to switch INPUT 1 and INPUT 2 at the same time with a certain level difference.

The AC Voltmeter consists of an impedance converter with high input impedance, a voltage divider, a preamplifier, an indicator circuit, an output circuit and a constant voltage circuit for each of INPUT 1 and INPUT 2 mutually independently. The ground lines of the circuits are floated from the chassis ground and casing ground.

The measuring range is 10 μ V ~ 300 V rms (-100 ~ +52 dBm, -100 ~ +50 dBv) [15 μ V ~ 500 V rms (-100 ~ +56 dBm, -100 ~ +54 dBv)] divided into 14 sub-ranges in 10-dB steps. The scales are graduated in equal divisions in r.m.s. value of sinusoidal wave. The measuring frequency range is 10 Hz ~ 500 kHz.

The meter is incorporated with a 100-kHz low pass filter. The use of this filter is very advantageous when the signal source impedance is high.

The output terminals of INPUT 1 and INPUT 2 provide AC output voltages of approximately 1 V [approximately 1.5 V] at full scale. Thus, the AC voltmeter can be used also as a monitor or a preamplifier.

2. SPECIFICATIONS

Nomenclature: AC Voltmeter

Model No.: 1834 [1854]

Indicating meter: 2-pointer type, dual scales in different colors,
1 mA FS for both scales

Scale values: r.m.s. value of sinusoidal wave, and dBm value with
1 mW 600Ω as reference.
dBv value with 1 V as 0 dB.

Input terminals: UHF-type receptacle and GND terminal
19 mm (3/4") spacing

Input resistance: 10 M Ω +3%, for each range

Input capacitance: 100 μ V ~ 1 V [150 μ V ~ 1.5 V] ranges 40 pF or less
3 V ~ 300 V [5 V ~ 500 V] ranges 30 pF or less

Maximum allowable input voltages

100 μ V ~ 1 V [150 μ V ~ 1.5 V] ranges

AC component: 150 V in rms value, \pm 200 V in peak value

DC component: \pm 400 V

3 V ~ 300 V [5 V ~ 500 V] ranges

AC component: 300 V [500 V] in rms value,

\pm 450 V [\pm 700 V] in peak value

DC component: \pm 400 V

Ranges: 14 ranges

RMS scale: 100/300 μ V, 1/3/10/30/100/300 mV and 1/3/10/30/100/300 V
 [150/500 μ V, 1.5/5/15/50/150/500 mV and 1.5/5/15/50/150/500 V]

dBv, dB scale: -80/-70/-60/-50/-40/-30/-20/-10 and 0/10/20/30/40/50 dB

Accuracy: +3% of full scale at 1 kHz

Stability: Better than 0.2% of full scale for +10% variation of power line voltage

Operating ambient temperature range: 5°C ~ 35°C

Operating ambient humidity range: Up to 85% RH

Temperature coefficient: 0.05%/°C at 1 kHz (for reference only)

Frequency response: 10 Hz ~ 500 kHz ... +5% with reference to 1 kHz
 20 Hz ~ 200 kHz ... +3% with reference to 1 kHz

Internal filter: 100 kHz low pass filter
 (The filters are connected in the INPUT 1 and INPUT 2 circuits only when the 100 kHz pushbutton switch is depressed, and the meter indication and external output signal are reduced by approximately 3 dB at 100 kHz.)

Noise: (With input terminals shorted)

| Range | Filter in | Filter out |
|---------------------|---------------|---------------|
| 300 μ V ~ 300 V | 1% FS or less | 1% FS or less |
| 100 μ V | 2% FS or less | 4% FS or less |

Filter in: When 100 kHz filters are connected

Filter out: When 100 kHz filters are disconnected

The noise affects the indicated value as follows:

$$\text{Indicated value} = \sqrt{(\text{Signal value})^2 + (\text{Noise})^2}$$

- Crosstalk: Either one of the input terminals shorted 600Ω...
140 dB or over
- Output terminals: 5-way binding posts, 19 mm (3/4") spacing
- Output impedance: Approx. 600Ω
- Output voltage: Approx. 1 V [1.5 V] rms at full scale of "1.0"
"15" scale
- Distortion factor: Less than 1%, at full scale, 1 kHz, 10 mV range
- Frequency response: With input resistor 10 MΩ and input capacitor 30 pF
connected to output terminal,
7 Hz ~ 250 kHz, +1 dB ~ -3 dB
- Power requirements: 100 V AC, 50/60 Hz, approx. 6 VA
(can be modified to 100 V ~ 120 V or 200 ~ 240 V
with internal connection change)
- Dimensions: 134 (W) x 164 (H) x 270 (D) mm
(Maximum dimensions); 140 (W) x 190 (H) x 340 (D) mm
- Weight: Approx. 3.8 kg
- Accessories: Type 941B terminal adaptor 2
Instruction manual 1

3. OPERATION INSTRUCTIONS

3.1 Explanation of Front and Rear Panels

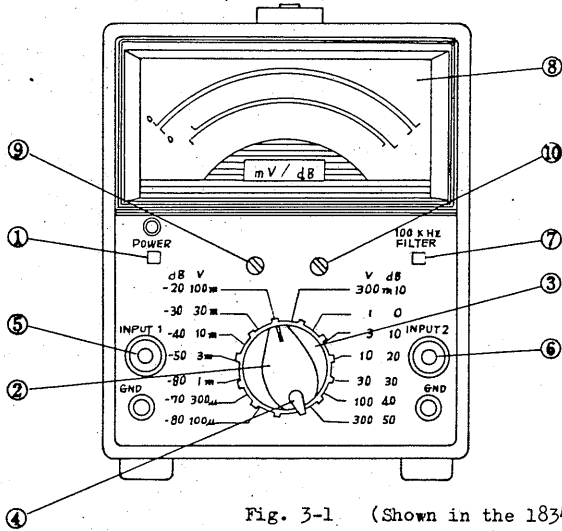

Fig. 3-1. (Shown in the 1834)

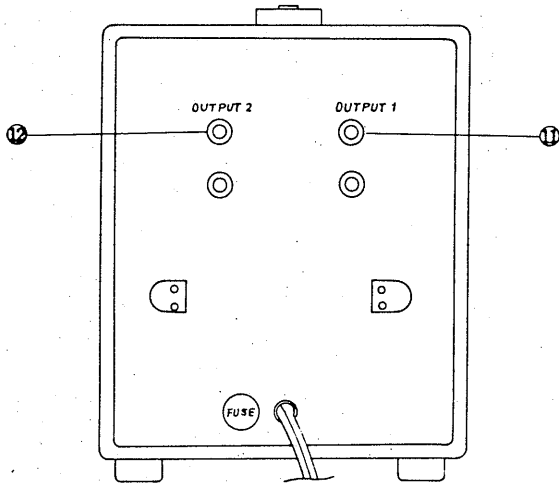

Fig. 3-2

- ① POWER The pushbutton switch for meter power ON-OFF. The depressed and locked position is for ON. As the button is pushed again, it pops out into the OFF position. The meter pointers may deflect irregularly for approximately 10 sec after the power is turned ON, but this is not an abnormal indication.
- ② INPUT 1 The knob located in the center of front panel, range switch: for selection of 14 ranges covering a total range of 100 μ V ~ 300 V [150 μ V ~ 500 V].
- ③ INPUT 2 The black figures are for V values. The blue range switch: figures are for dB values. To prevent overload to the instrument, start measurement with higher ranges and gradually turn the switch to lower ranges, observing the meter deflection. The inner arrow knob is for range selection of INPUT 1 and the outer round knob is for that of INPUT 2.
- ④ Range switch lock button: The black button on the inner knob. The depressed and locked position is for simultaneous switching of INPUT 1 and INPUT 2 in gang. The unlocked and popped out position is for switching of individual channels.
- ⑤ INPUT 1 terminal: The terminal to which the signal to be measured is applied. Consists of a UHF-type receptacle and a GND binding-post terminal. Connection can be conveniently made with a UHF-type
- ⑥ INPUT 2 terminal: (5/8"-24) or N-type (16P-1P) plug or with a standard 2-pin banana plug (spacing: 3/4" = 19 mm).

Connection can be made also with a banana plug for to the center conductor of the receptacle. When "Kikusui 941B Terminal Adaptor" is

inserted, connection can be made with a banana plug, spade lug, alligator clip, 2-mm tip or a wire of smaller than 2 mm as is the case for the GND terminal.

The outer conductor and GND terminal are electrically connected to the meter panel and chassis.

- ⑦ 100 kHz filter: As you press this pushbutton switch to the depressed state (filter-in state), the 100 kHz low pass filter (-3 dB at 100 kHz) are connected to the circuits of INPUT 1 and INPUT 2. As you press the button again, it is reset to the popped-up state (filter-out state) and the filters are disconnected from the circuits.

Frequency response of meter indication when in the filter-in state is shown in Fig. 3-3.

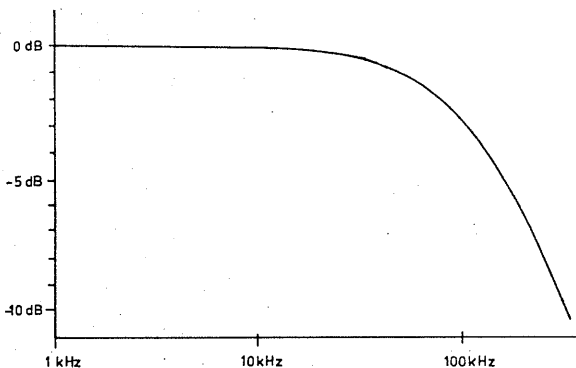

Fig. 3-3

⑧ Indicating
meter:

The indicating meter has two pointers --
red pointer for INPUT 1 and black pointer
for INPUT 2. It has four scales as follows:

1) "1.0" ["15"] scale:

For 100 μ V, 1/10/100 mV and 1/10/100 V
[150 μ V, 1.5/15/150 mV and 1.5/15/150 V] ranges.
Scale "1.0" ["15"] at 1 [1.5] mV
range is for 1.0 [1.5] mV and at 100
[150] V range is for 100 [150] V.

2) "3" ["5"] scale:

For 300 μ V, 3/30/300 mV and 3/30/300 V
[500 μ V, 5/50/500 mV and 5/50/500 V] ranges.
Meanings of scale figures are the same
with those of the case of "1.0" ["15"]
scale.

3) "dBv" scale:

For measurement in dBv value with reference
to 1 V. The same scale is used for all of
14 ranges of -80 to +50 dB.

4) "dBm" scale:

For measurement in dBm value with
reference to 1 mW 600 Ω . The same scale
is used for all of 14 ranges of -80 to
+50 dBm.

⑨ ⑩ ZERO
adjustment:

The red screw ⑨ is for mechanical zero
adjustment of INPUT 1 pointer (red) of
indicating meter; the black screw ⑩ is
for mechanical zero adjustment of INPUT 2
pointer (black).

⑪ ⑫ OUTPUT terminals: The output terminals on the rear panel, which provide output signals when the meter is used as an amplifier. OUTPUT terminals ⑪ provide the output for INPUT 1 and OUTPUT terminals ⑫ provide that for INPUT 2. The black ones are ground terminals.

Connection can be most conveniently made with 2-pin banana plugs connected to a coaxial cable. Connection can also be made, as is the case for "Kikusui Type 941B" Terminal Adaptor, with banana plugs, spade lugs, alligator clips, 2-mm tips, or wires of 2 mm or less.

3.2 Preparations for Measurement

- 1) Turn OFF the POWER switch at the left-hand side on the front panel.
- 2) Check that the pointers are accurately in the center of the zero scale position. If they are not in this position, adjust them accurately to this position. If the meter power has been turned ON, turn it OFF and wait for approximately 5 minutes so that the pointers are stabilized in positions close to the zero position and then perform the zero adjustment.
- 3) Connect the meter power plug to an AC line power outlet of 100 V (can be modified to 100 V ~ 120 V or 200 V ~ 240 V with internal connection change) 50/60 Hz AC.
- 4) Set the range selector in the 300 V [500 V] position.
- 5) Turn ON the POWER switch. The Power pilot lamp will light indicating that the meter power is turned on. The meter pointers may deflect irregularly for about 10 seconds when the switch is turned ON or OFF, but this is not an abnormal indication.

783431

- 6) When the pointers are stabilized, the meter is ready for measurement.
- 7) For measurement at a high sensitivity, connect the 100 kHz low pass filter (-3 dB at 100 kHz) by depressing pushbutton ⑦ of Fig. 3-3, in order that the input signal can be measured with low noise. This feature is especially advantageous when the signal source impedance is high.

3.3 AC Voltage Measurement

- 1) When the measured signal level is low or the measured signal source impedance is high, the input line is susceptible to external noise. To guard against noise, shielded wires or a coaxial cable should be used depending on the noise frequency. When the measured signal is a low frequency and a higher level and its source impedance is low, measurement can be conveniently performed using the 941B Terminal Adaptor which is supplied as an accessory of the meter.

Note:

When measurement is done at the $100 \mu\text{V} \sim 1 \text{ mV}$ [$150 \mu\text{V} \sim 1.5 \text{ mV}$] ranges, it is recommendable to use a shielded cable or a coaxial cable in order to prevent coupling by radiation from the indicating meter. If a conventional coaxial cable (such as 3G2V) is used, noise may be caused due to movement or bending of the cable. It is most recommendable to use a low noise cable when measurement is done at a high sensitivity.

- 2) When the signals of both INPUT 1 and INPUT 2 are required to be monitored by connecting an oscilloscope or other instrument to the output circuits, a ground loop can be formed between this equipment and the monitor instrument because the GND of INPUT 1 circuit is electrically connected with that of INPUT 2 circuit through the equipment chassis and casing. In order to avoid formation of such ground loop, either use mutually independent monitor circuit for INPUT 1 and INPUT 2 or keep disconnected the ground line of the output circuit of INPUT 1 or INPUT 2. Note that, if a ground loop is formed, correct waveform measurement cannot be expected due to waveform distortions or beats caused by external magnetic induction or by a current which flows in the common impedance.

- 3) In order to prevent overload to the meter, start measuring with the highest range and gradually lower the range observing the pointer deflection.
- 4) Use the "1.0, 3" ["15, 50"] scales of the indicating meter. The scale values are shown in Table 3-1.

Table 3-1

| Range | | | Scale | Scale factor | | Unit | Gain |
|-------------|--------|-------|--------|--------------|-------|---------|-------|
| 100 μ V | 150 mV | -80dB | 1.0 15 | x 100 | x 10 | μ V | 80dB |
| 300 μ V | 500 mV | -70dB | 3 50 | x 100 | x 10 | μ V | 70dB |
| 1mV | 1.5mV | -60dB | 1.0 15 | x 1 | x 0.1 | mV | 60dB |
| 3mV | 3 mV | -50dB | 3 50 | x 1 | x 0.1 | mV | 50dB |
| 10mV | 15 mV | -40dB | 1.0 15 | x 10 | x 1 | mV | 40dB |
| 30mV | 50 mV | -30dB | 3 50 | x 10 | x 1 | mV | 30dB |
| 100mV | 150 mV | -20dB | 1.0 15 | x 100 | x 10 | mV | 20dB |
| 300mV | 500 mV | -10dB | 3 50 | x 100 | x 10 | mV | 10dB |
| 1 V | 1.5 V | 0dB | 1.0 15 | x 1 | x 0.1 | V | 0dB |
| 3 V | 5 V | 10dB | 3 50 | x 1 | x 0.1 | V | -10dB |
| 10 V | 15 V | 20dB | 1.0 15 | x 10 | x 1 | V | -20dB |
| 330 V | 50 V | 30dB | 3 50 | x 10 | x 1 | V | -30dB |
| 100 V | 150 V | 40dB | 1.0 15 | x 100 | x 10 | V | -40dB |
| 300 V | 500 V | 50dB | 3 50 | x 100 | x 10 | V | -50dB |

- 5) To measure the input voltage in dBm value with reference to 1 mW 600 Ω , use the common dBm scale and determine the value as follows:
The "0" position in the center position of the dBm scale represents the level of each range. Add the dBm value of the range to the dBm value indicated by the pointer, to determine the dBm value of the measured signal.

Example 1: When the pointer indication is 2 (dBm) at the "30 dB (30 V) [(50 V)] range", determine the signal level as

$$2 + 30 = 32 \text{ dBm}$$

Example 2: When the pointer indication is 1 (dBm) at the "-20 dB (100 mV) [(150 mV)] range", determine the signal level as

$$1 + (-20) = 1 - 20 = -19 \text{ dBm}$$

- 6) To measure the input voltage in dBv value with reference to 1 V, use the dBv scale in common for all ranges. The measuring method is the same as above.

Example 1: When the pointer indication is -2 (dBv) at the "-30 dB (30 V) [(50 V)] range", determine the signal level as

$$-2 + 30 = 28 \text{ dBv}$$

Example 2: When the pointer indication is -5 (dBv) at the "-20 dB (100 mV) [(150 mV)] range", determine the signal level as

$$-5 + (-20) = -5 - 20 = -25 \text{ dBv}$$

3.4 AC Current Measurement

To measure an AC current (I) with this meter, feed the current through a non-inductive resistor of a known resistance (R) and measure the voltage drop (E) developed across the resistor. The current can be determined as $I = E/R$. In this case, note that the "-" input terminal of the meter must be grounded.

Example: Measure the heater current of a vacuum tube (nominal 6.3 V, 0.3 A).

Assume that a non-inductive resistor of 0.1Ω was connected as shown Fig. 3-4 and the meter reading was 29 mV. The current can be determined as follows:

$$I = \frac{29 \times 10^{-3}}{0.1} = 290 \times 10^{-3} \text{ (A)} = 290 \text{ (mA)}$$

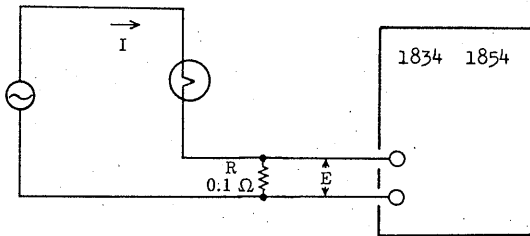

Fig. 3-4

3.5 Use as an Output Meter

Measuring the voltage (E) developed across a certain impedance (X), the apparent power (VA) in the impedance (X) can be determined as $VA = E^2/X$. Assuming that the impedance (X) is a pure resistance (R), the power (P) consumed in the resistance (R) is calculated as follows:

$$P = E^2/R$$

Since the meter scale is graduated in dBm value, the power can be directly read in the dB value when the resistance (R) is 600 Ω. If the load resistance is within a range of 1 Ω to 10 KΩ, the power can be read in decibels by adding the value obtained from the decibal conversion charts, Figs 3-5 and 3-6.

3.6 Waveform Errors

This meter is a "mean-value indicating" AC voltmeter which indicates a value proportional to the mean value of the measured voltage. The meter scale are calibrated in the r.m.s. value of a sinusoidal wave. If the measured signal waveform is distorted, the meter does not indicate the correct r.m.s. value but errors

are introduced. Rates of errors caused by waveform distortions are shown in Table 3-2.

Table 3-2

| Measured voltage | r.m.s. value (%) | Meter indication (%) |
|---|------------------|----------------------|
| Amplitude 100% fundamental wave | 100 | 100 |
| 100% fundamental wave +10% 2nd harmonic wave | 100.5 | 100 |
| 100% fundamental wave +20% 2nd harmonic wave | 102 | 100 - 102 |
| 100% fundamental wave +50% 2nd harmonic wave | 112 | 100 - 110 |
| 100% fundamental wave +10% 3rd harmonic wave | 100.3 | 95 - 104 |
| 100% fundamental wave +20% 3rd harmonic wave | 102 | 94 - 108 |
| 100% fundamental wave +50% 3rd harmonic wave | 112 | 90 - 116 |

3.7 How to Use the Decibel Chart

1) Decibel

Bel (B) is a unit of measure for comparing two power levels in terms of the common logarithm with 10 as its base.

Decibel (dB) is one-tenth of Bel (B) as indicated with the affix "d" and it is expressed as follows:

$$dB = 10 \log_{10} \frac{P_2}{P_1}$$

In other words, the dB value indicates the ratio of power P_2 with respect to power P_1 in terms of the common logarithm multiplied by a factor of 10.

$$\text{dB} = 20 \log_{10} \frac{E_2}{E_1} \quad \text{or} \quad 20 \log_{10} \frac{I_2}{I_1}$$

Though decibel initially was meant for representing the ratio of power levels, it since long ago has become to be used in a broader sense to indicate a ratio between two numbers in terms of common logarithm.

For an example, when the input voltage of an amplifier is 10 mV and its output is 10 V, the gain is $10\text{V}/10\text{mV} = 1000$. In terms of decibel, the amplifier gain is expressed as follows:

$$\text{Gain} = 20 \log_{10} \frac{10 \text{ V}}{10 \text{ mV}} = 60 \text{ (dB)}$$

For a standard RF signal generator for another example, its output voltage is given in terms of dB value with reference to 1 μV . When the output voltage is 10 mV, it is expressed as follows:

$$10 \text{ mV} = 20 \log \frac{10 \text{ mV}}{1 \mu\text{V}} = 80 \text{ (dB)}$$

When given in a dB value, the reference value or the 0 dB value should be indicated. In the case of the signal generator of the above example, the output voltage should be indicated as 10 mV = 80 dB (1 μV = 0 dB) with the 0 dB value given enclosed in parentheses.

2) dBm, dBv

Term dBm means dB(mW). It represents a power ratio with reference to 1 mW as 0 dB. In general the term is for a case that the impedance of the power measuring point is 600 Ω or the term signifies dB (mW 600 Ω).

When the power and impedance are specified as above, decibel can represent voltage and current as well as power. Term dBm is given in reference to the values as follows:

0 dBm = 1 mW or 0.775 V,
or 1.291 mA

Term dBv represents a voltage ratio with reference to 1 V as 0 dB. This term is widely used in audio engineering as it provides a convenient means of voltage level conversion.

Since the decibel scales of the AC Voltmeter are graduated in such dBm and dBv values, the indicated value must be converted when other value than "1mW, 600Ω" or "1V" is used for the reference value. Due to the nature of the logarithm, correction can be accomplished by adding a certain value to the meter reading. Refer to Figs. 3-5 and 3-6 for the correction values.

3) Decibel Conversion Chart

Fig. 3-5 shows a chart for converting ratios into decibel values. Decibel values are different according to whether the ratio is of power (or equivalent) or it is of voltage or current.

Example 1: What dB is 5 mW with reference to 1 mW?

Since the ratio is of power, the left-hand scale must be used. Calculating $5\text{mW}/1\text{mW} = 5$, the dB value is known to be 7 dB (mW) as indicated by the dotted line in the illustration.

Example 2: What are 50 mW and 500 mW in dB values with reference to 1 mW?

When the ratio is larger than 0.1 time or higher than 10, decibel values must be calculated through addition or subtraction using the relationship shown in Fig. 3-5.

$$50 \text{ mW} = 5 \text{ mW} \times 10 = 7 + 10 = 17 \text{ dB}$$

$$500 \text{ mW} = 5 \text{ mW} \times 100 = 7 + 20 = 27 \text{ dB}$$

Table 3-3

| Ratio | Decibel | |
|-----------------------------|-------------|--------------------------|
| | Power ratio | Voltage or current ratio |
| 10,000 = 1×10^4 | 40 dB | 80 dB |
| 1,000 = 1×10^3 | 30 dB | 60 dB |
| 100 = 1×10^2 | 20 dB | 40 dB |
| 10 = 1×10^1 | 10 dB | 20 dB |
| 1 = 1×10^0 | 0 dB | 0 dB |
| 0.1 = 1×10^{-1} | -10 dB | -20 dB |
| 0.01 = 1×10^{-2} | -20 dB | -40 dB |
| 0.001 = 1×10^{-3} | -30 dB | -60 dB |
| 0.0001 = 1×10^{-4} | -40 dB | -80 dB |

Example 3: What is 15 mV in dB(V) value?

Since this decibel is referenced to 1 V, calculate at first as $15\text{mV}/1\text{V} = 0.015$. Next, using the voltage/current scale, calculate as $0.015 = 1.5 \times 0.01 = 3.5 + (-40) = -36.5 \text{ dB(V)}$ or in the reverse as $1\text{V}/15\text{mV} = 66.7$.

$$66.7 = 6.67 \times 10 \quad 16.5 + 20 = 36.5 \text{ dB(V)}$$

4) Decibel Addition Chart

Fig. 3-6 shows an addition chart which is used when calculating the power from the dBm value determined by this meter.

Example 1: The voltage across the voice coil of a speaker of 8 Ω was measured with this meter and the indication was -4.8 dBm. What was the power (apparent power) being sent to the speaker?

783739

Referring to Fig. 3-6, the value to be added is determined to be +18.8 as indicated with the dotted line in Fig. 3-6. The power level can be known by adding this value to the indicated value as follows:

$$\text{dB (mW, } 8\Omega) = -4.8 + 18.8 = +14$$

The value of 14 dB (mW, 8 Ω) can be converted referring to Fig. 3-5 as 14 dB (mW, 8 Ω) \rightarrow 25 mW.

Example 2: What voltage (V) is required to feed a power of 1 W to a load of 10 k Ω .

Since 1 W is 1000 mW or 30 dB (mW), a voltage which will give 30 dB (mW, 10 k Ω) should be calculated. Referring to Fig. 3-6, the value to be added for 600 Ω \rightarrow 10 k Ω is known to be -12.2. Therefore, the indication of this meter should be 30 - (-12.2) = 42.2 on the dB (mW, 600 Ω) scale. The required voltage is such that it causes a deflection of 42.2 - 40 = 2.2 dBm on the 40 dB (0 - 100 V) [(0 - 150 V)] range. Thus, the voltage is calculated to be 42.2 dBm = 100 V.

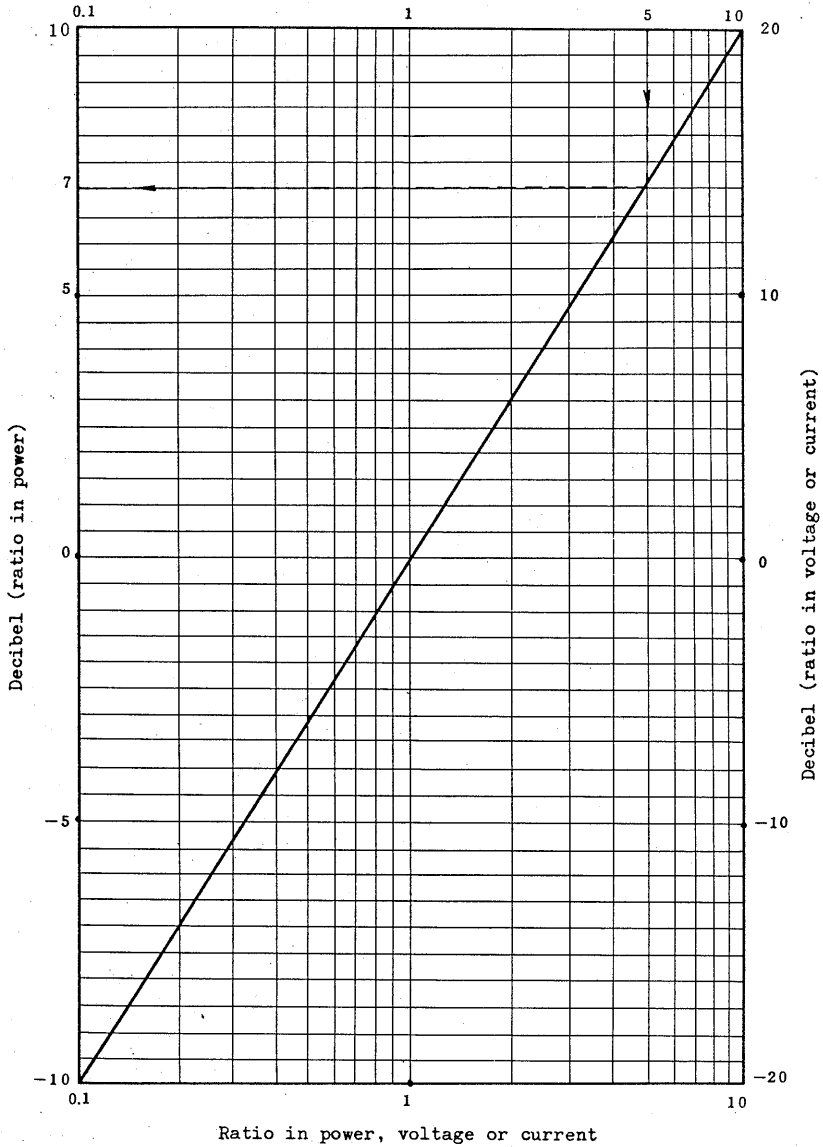

Decibel conversion chart

Fig. 3-5

783/111

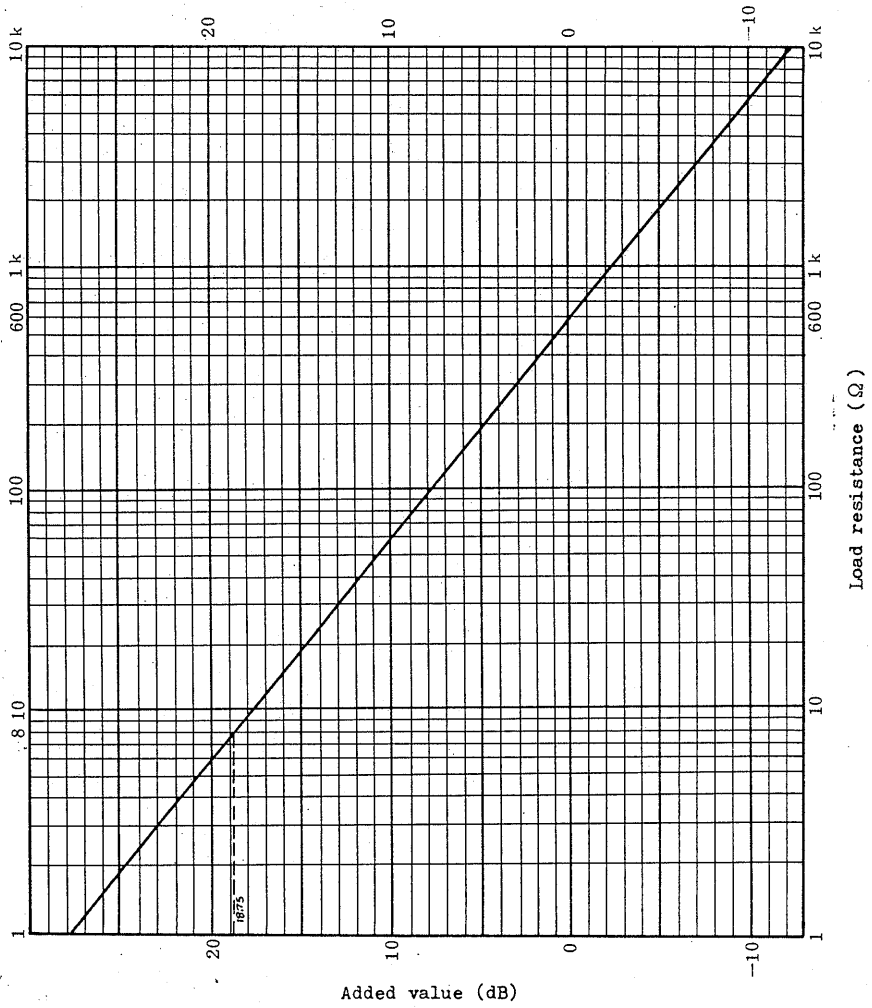

Decibel addition chart

Fig. 3-6

7231113

4. OPERATING PRINCIPLE

4.1 Construction

The 1834/1854 AC Voltmeter consists of an input section (a preamplifier, a former-stage attenuator, an impedance converter), a latter-stage attenuator, a main amplifier, an output circuit, and a power supply for each of two channels of INPUT 1 and INPUT 2.

4.2 Input Section

(a) $100 \mu\text{V} \sim 3 \text{ mV}$ [$150 \mu\text{V} \sim 5 \text{ mV}$] ranges:

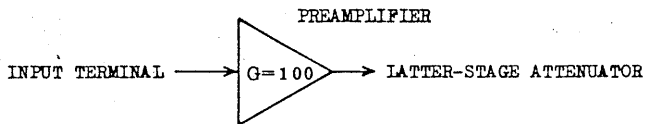

Fig. 4-2

As shown in Fig. 4-2, the input signal is sent to the latter-stage attenuator after being amplified by 100 times by the preamplifier.

(b) $10 \text{ mV} \sim 1 \text{ V}$ [$15 \text{ mV} \sim 1.5 \text{ V}$] ranges:

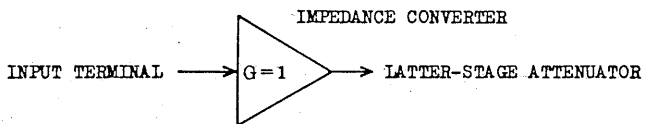

Fig. 4-3

As shown in Fig. 4-3, the input signal is sent to the latter-stage converter through the impedance converter.

783444

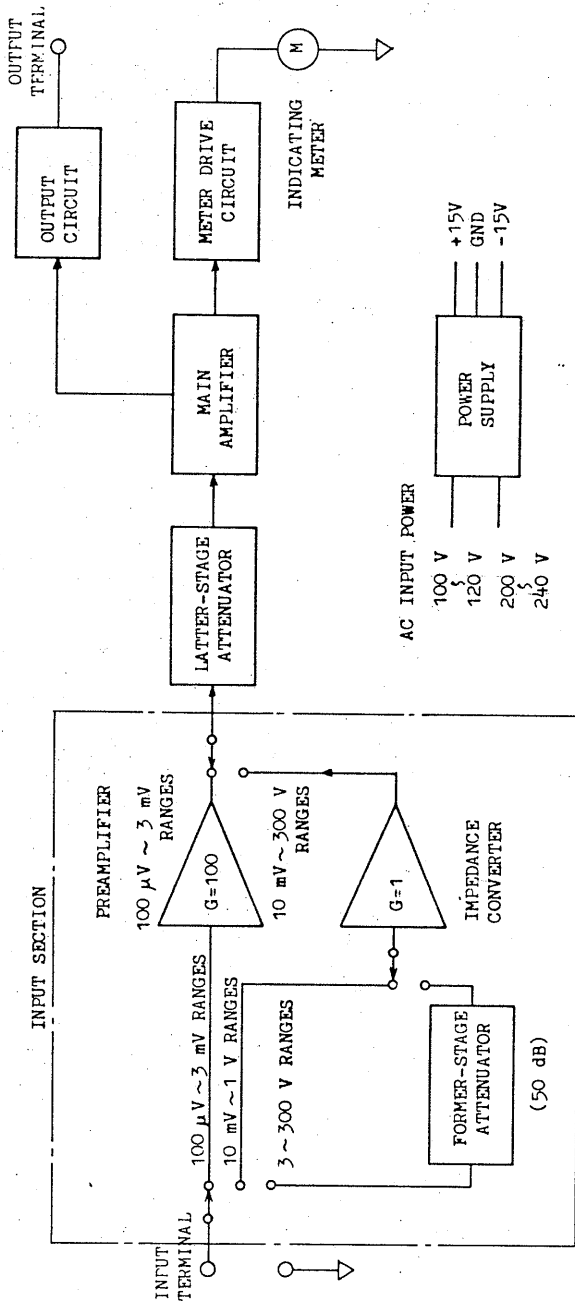

Fig. 4-1 Block diagram of the AC Voltmeter (Either one of two channels)

(c) 3 V ~ 300 V (5 V ~ 500 V) ranges:

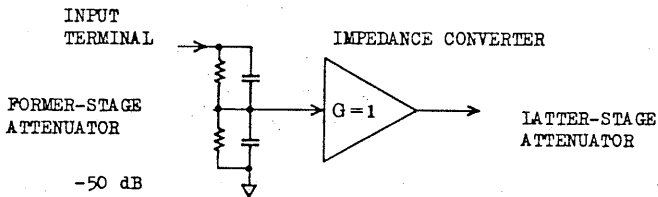

Fig. 4-4

As shown in Fig. 4-4, the input signal is sent to the latter-stage attenuator through the former-stage attenuator (50 dB) and impedance converter.

4.3 Latter-stage Attenuator (ATT 2-1 or ATT 2-2)

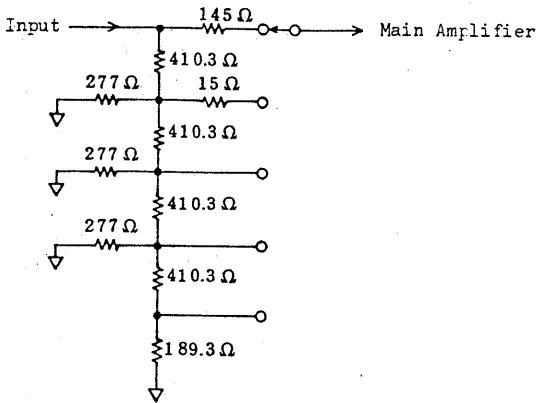

Fig. 4-5

The input signal is attenuated in 10-dB steps (0/10/20/30/40 dB) with the latter-stage attenuator as shown in Fig. 4-5.

783445

4.4 Main Amplifier

The main amplifier amplifies the output signal of the latter-stage attenuator. This amplifier is a negative-feedback amplifier consisting of three transistors (Q111 ~ Q113, Q211 ~ Q213).

Its gain is approximately 20 dB. Its output is sent to the indicating meter drive circuit and to the external output circuit.

4.5 Meter Drive Circuit

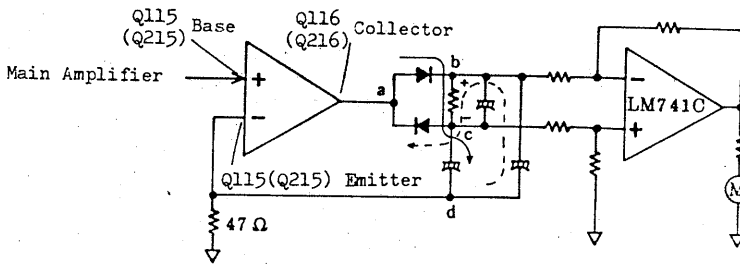

Fig. 4-6

The meter drive circuit has transistors (Q115, Q116 or Q215, Q216) and IC (MC101 or MC201). A feedback current flows from the collector of transistor Q116 (Q216) to the emitter through the rectifying diodes. Due to this feedback, the diodes are driven with almost constant currents and their non-linearity is compensated for and, consequently, the meter deflection becomes linear. This principle is shown in Fig. 4-6.

For the positive half-cycles of the amplifier output voltage (point a), the current flows in the circuit of a → b → c → d as indicated with the solid line; for the negative half-cycles, the current flows in the circuit of d → b → c → a as indicated with the dotted line. Between b and c, the rectified current flows in the polarity as in Fig. 4-6. This DC voltage is amplified and fed to the indicating meter.

783446

4.6 Output Circuit

The collector signal of transistor Q113 (Q213) of the main amplifier is amplified by transistor Q114 (Q214) and the amplified signal is fed to the output terminal with a 600-ohm output impedance. The output signal is approximately 1 V [1.5 V] for the meter full scale.

4.7 Power Supply

The power supply circuit has two constant-voltage circuits for +15 V supply and -15 V supply.

The +15 V power supply circuit generates the voltage with the voltage IC (MC103 or MC202).

The -15 V power supply circuit is employed the operational amplifier (MC103 or MC203), and it's reference voltage is the +15 V power supply. Q117 and Q118 (Q217 and Q218) are the series pass transistors of the +15 V power supply.

Q119 and Q120 (Q219 and Q220) are the series pass transistors of the -15 V power supply.

7892777

5. MAINTENANCE

5.1 Inspection of Internal Components

To gain access to the internal components, remove the top cover after removing the two clamping-screws on the top and other two clamping-screws at each of right and left side and remove the bottom cover after removing the four clamping-screws at the bottom. The layouts of components are shown in Figs. 5-1 and 5-2.

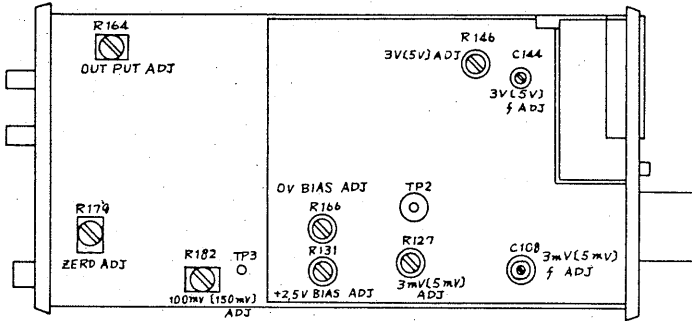

Fig. 5-1 (INPUT 1 channel)

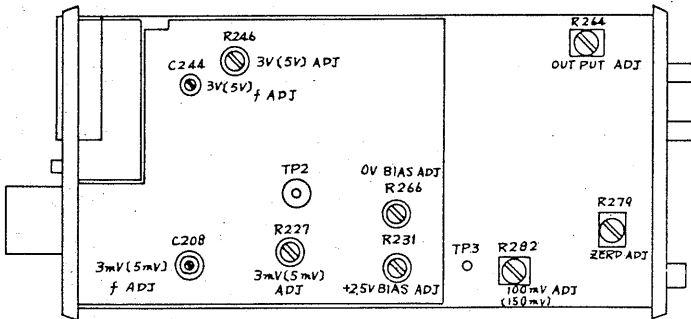

Fig. 5-2 (INPUT 2 channel)

783448

5.2 Adjustment and Calibration (See Fig. 5-1 and Fig. 5-2)

When the instrument has become not satisfying its specification after a long time of use or a repair, it must be adjusted and calibrated following in the due order the procedures explained in this section.

1) Check of regulated voltage circuit:

Check the voltages of the test points with respect to the GND, and shown in Table 5-1.

Table 5-1

| Test point | Voltage with respect to GND |
|-------------------|-----------------------------|
| TP1, +13 V supply | 10 ~ 16 V |
| TP5, +15 V supply | 13 ~ 17 V |
| TP6, -15 V supply | -13 ~ -17 V |

2) Mechanical zero adjustment of indicating meter:

So adjust the mechanical zero control ((6) and (10) of Fig. 3-1) that the meter pointer indicates the zero point of the scale.

Before this adjustment, ensure that a period of about 5 minutes has elapsed after turning-OFF the instrument power and the meter pointer has been settled.

3) Bias adjustment:

So adjust potentiometer R166 (R266) of the indicating meter drive circuit that the voltage between test point TP3 and GND becomes 0 V. Also, so adjust potentiometer R131 (R231) of the preamplifier of the input section that the voltage between test point TP2 and GND becomes +2.5 V.

(at 100 μ V [150 μ V] range, with short the input terminals)

4) Electrical zero adjustment of indicating meter:

Set the RANGE switch ((2), (3) of Fig. 3-1) at the 300 V (500 V) range, short the input terminals, and so adjust potentiometer R179 (R279) of the meter drive circuit that the meter ((8) of Fig. 3-1) indicates accurately the zero point of the scale.

5) Sensitivity and output adjustment (see the note):

Set the RANGE switch at the 100 mV (150 mV) range, apply a calibration signal of 100 mV (150 mV) 400 Hz or 1000 Hz to the input terminal, and so adjust potentiometer R182 (R282) of the meter drive circuit that the meter accurately indicates the full scale position. Next, so adjust potentiometer R164 (R264) that the voltage of output terminal becomes 1 V (1.5 V).

6) Preamplifier (see the note):

Set the RANGE switch at the 3 mV (5 mV) range, apply a calibration signal of 3 mV (5 mV) 400 Hz to the input terminal, and so adjust potentiometer R127 (R227) of the meter drive section that the meter indicates the full scale position. Next, raise the calibration signal frequency to 400 kHz and so adjust trimmer capacitor C108 (C208) that the meter indicates the full scale position. Repeat alternately (for several times) the adjustments at 400 Hz and 400 kHz with trimmer capacitor C108 (C208) so that the meter indicates the full scale at both frequencies.

7) Adjustment of latter-stage attenuator (see the note):

Set the RANGE switch at the 3 V (5 V) range, apply a calibration signal of 3 V (5 V) 400 Hz to the input terminal, and so adjust potentiometer R146 (R246) that the meter indicates the full scale. Next, change the calibration signal frequency to 40 kHz, and so adjust trimmer capacitor C123 (C223) that the meter indicates the full scale.

783450

Note: For this calibration, keep the 100 kHz filter in the disconnected state (the 100 kHz pushbutton not depressed).

5.3 Troubleshooting

The instrument is manufactured under stringent quality control and inspection programs and normally are free of troubles. Should any failure been caused notwithstanding check the circuit voltages to locate the cause of failure.

Circuit voltages without input signal for the instrument are shown in Tables 5-1 through 5-6. (The voltages are with respect to the ground and as measured with a 11-M Ω input resistance VTVM (Kikusui Series 107)). The values are without adjustment of the AC line voltage and may differ slightly from set to set.

Pins of transistors and IC's as viewed from the bottom, are shown in Fig. 5-3.

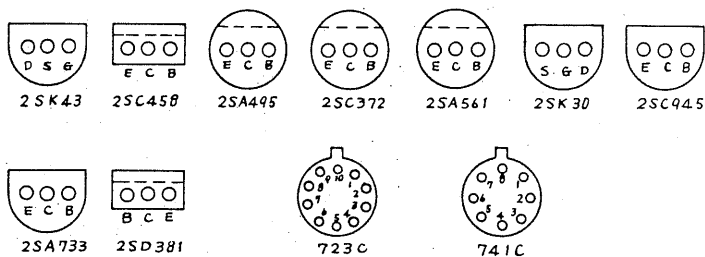

Fig. 5-3 Pins of transistors and IC's
(bottom view)

783451

1) Preamplifier

Table 5-2

| Transistor | Emitter or source | Collector or drain |
|--------------------|-------------------|--------------------|
| Q101 (Q201) 2SC458 | 4 V | 7 V |
| Q102 (Q202) 2SK43 | 0.4 ~ 0.9 V | 4 V |
| Q103 (Q203) 2SC458 | 6.5 V | 12 V |
| Q104 (Q204) 2SA495 | 6.5 V | -11 V |
| Q105 (Q205) 2SC372 | -15 V | 0 V |
| Q106 (Q206) 2SC372 | 3 V | 14 V |
| Q107 (Q207) 2SA561 | 3 V | -15 V |
| Q108 (Q208) 2SC372 | 12.5 V | 15 V |

2) Impedance converter

Table 5-3

| Transistor | Emitter or source | Collector or drain |
|--------------------|-------------------|--------------------|
| Q109 (Q209) 2SK30A | 0.25 V | 15 V |
| Q110 (Q210) 2SC372 | -0.4 V | 14 V |

3) Main amplifier and output circuit

Table 5-4

| Transistor | Emitter | Collector |
|--------------------|---------|-----------|
| Q111 (Q211) 2SC372 | 0.1 V | 6 V |
| Q112 (Q212) 2SA495 | 6.5 V | 0.5 V |
| Q113 (Q213) 2SC372 | 6.5 V | 11 V |
| Q114 (Q214) 2SA495 | 12 V | 4 V |

4) Meter drive circuit

Table 5-5

| Transistor | Emitter | Collector |
|--------------------|---------|-----------|
| Q115 (Q215) 2SA495 | -0.04 V | -12 V |
| Q116 (Q216) 2SC372 | -12 V | 0.5 V |

MC101 No. 6 pin (with input 0 V) Approx. 0 V

5) Power supply (See Table 5-1)

Table 5-6

| IC | |
|--------------------|-----------------------|
| MC102 (MC202) 723C | Pin No. 4 6.8 7.8 V |
| MC103 (MC203) 741C | Pin No. 2 Approx. 0 V |

783453

5.4 AC Line Voltage Modification

The primary winding of the power transformer has taps for "100 V SYSTEM" and "200 V SYSTEM".

The 1834/1854 can be modified for operation on 100 V ~ 120 V or 200 V ~ 240 V AC power. For this modification, disconnect No. 1 tap wire (brown, normally) of transformer at the rear panel, and connect No. 2 tap wire (red, normally), so that the meter can be operated for 200 V ~ 240 V AC power.

Table 5-7

| AC line voltage | Tap wire No. | Wire color |
|-----------------|--------------|------------|
| 0 V | 0 | Black |
| 100 V ~ 120 V | 1 | Brown |
| 200 V ~ 240 V | 2 | Red |

Note: Colors of wires subject to change without notice.
Be sure to check the transformer tap wire number.

783454